

Installation Support • Soporte de Instalación • Support d'Installation

Personal Assistance, Product Specs, & "How-to" Questions:

Asistencia personal, especificaciones del producto y preguntas sobre "cómo hacerlo":

Aide personnelle, spécifications du produit et questions « pratico-pratiques » :

**1-800-PFAUCET (732-8238)**

**pfisterfaucets.com/support**

Installation Videos Available  
Videos de instalación a disposición  
Vidéos d'installation disponibles



pfisterfaucets.com/videos



**WARNING / ADVERTENCIA / AVERTISSEMENT**

To reduce the risk of injury or property damage, read all instructions before installing product. Wear safety goggles. Product must be installed in accordance with all state & local plumbing & building codes. Call a professional if you are uncertain about installing this product.

Para disminuir el riesgo de lesiones o daños a la propiedad, lea todas las instrucciones antes de instalar el producto. Utilice gafas de seguridad. El producto deberá instalarse de acuerdo con la normativa de plomería y construcción estatal y local. Llame a un profesional si no está seguro sobre cómo instalar este producto.

Pour réduire le risque de blessures ou de dommages, lire toutes les instructions avant d'installer le produit. Porter des lunettes de sécurité. Le produit doit être installé en conformité avec tous les codes de construction et de plomberie locaux et de l'état. Appelez un professionnel si vous n'êtes pas certain de la façon d'installer ce produit.

**Required Tools**

**Herramientas necesarias**

**Outils nécessaires**



Adjustable Wrench  
Llave ajustable  
Clé réglable



Safety Goggles  
Gafas de seguridad  
Lunettes de sûreté

**Additional Helpful Tools**

**Otras herramientas útiles**

**Outils supplémentaires utiles**

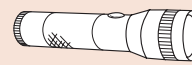

Flashlight  
Linterna  
Lampe De Poche



Cloth  
Paño  
Chiffon

**Parts in the Box**

**Piezas en la caja**

**Pièces dans la boîte**

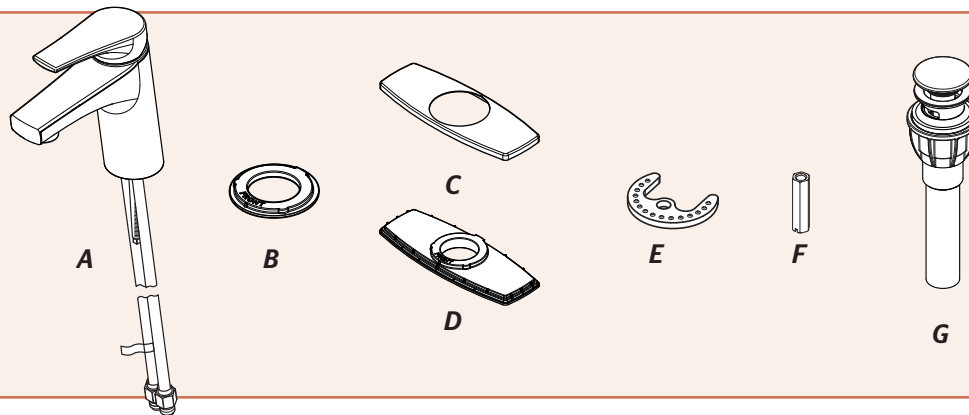

**1 Turn Off Water Supply • Cierre el suministro de agua • Couper l'alimentation en eau**



Locate water supply inlets and shut off the water supply valves. These are usually found under the sink or near the water meter. If you are replacing an existing faucet, remove the old faucet from the sink and clean the sink surface thoroughly.

Ubique las entradas del suministro de agua y cierre las válvulas de suministro de agua. Generalmente se encuentran debajo del fregadero o cerca del medidor de agua. Si se trata de un reemplazo de grifo, quite el grifo viejo y limpie completamente la superficie del fregadero.

Recherchez les entrées d'approvisionnement et fermer leurs robinets. Ces robinets se trouvent généralement sous l'évier ou près du compteur d'eau. Si vous remplacez un robinet existant, retirez, le vieux robinet de l'évier et nettoyer soigneusement la surface de ce dernier.

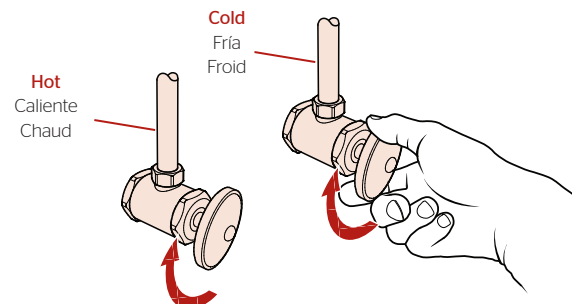

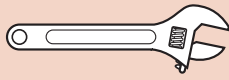
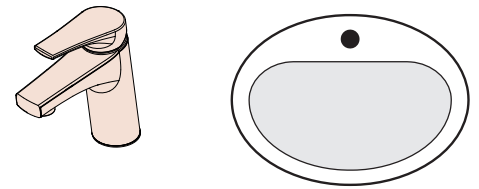
**2****OPTION 1: Install Faucet without Deckplate****OPCIÓN 1: Instale el grifo sin la placa de cubierta****OPTION 1: Installer le robinet sans le plate-forme**

Adjustable Wrench  
Llave ajustable  
Clé réglable

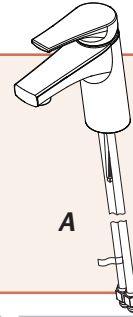
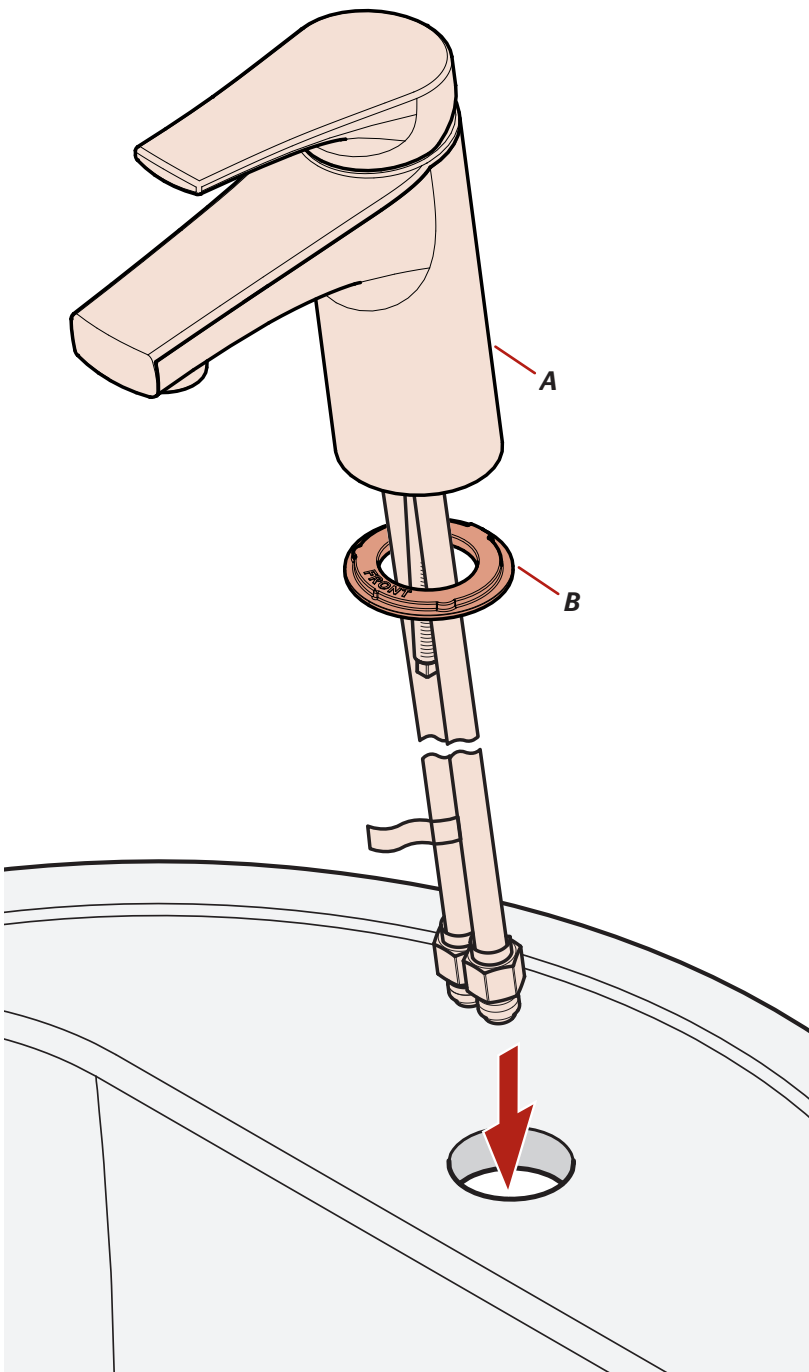
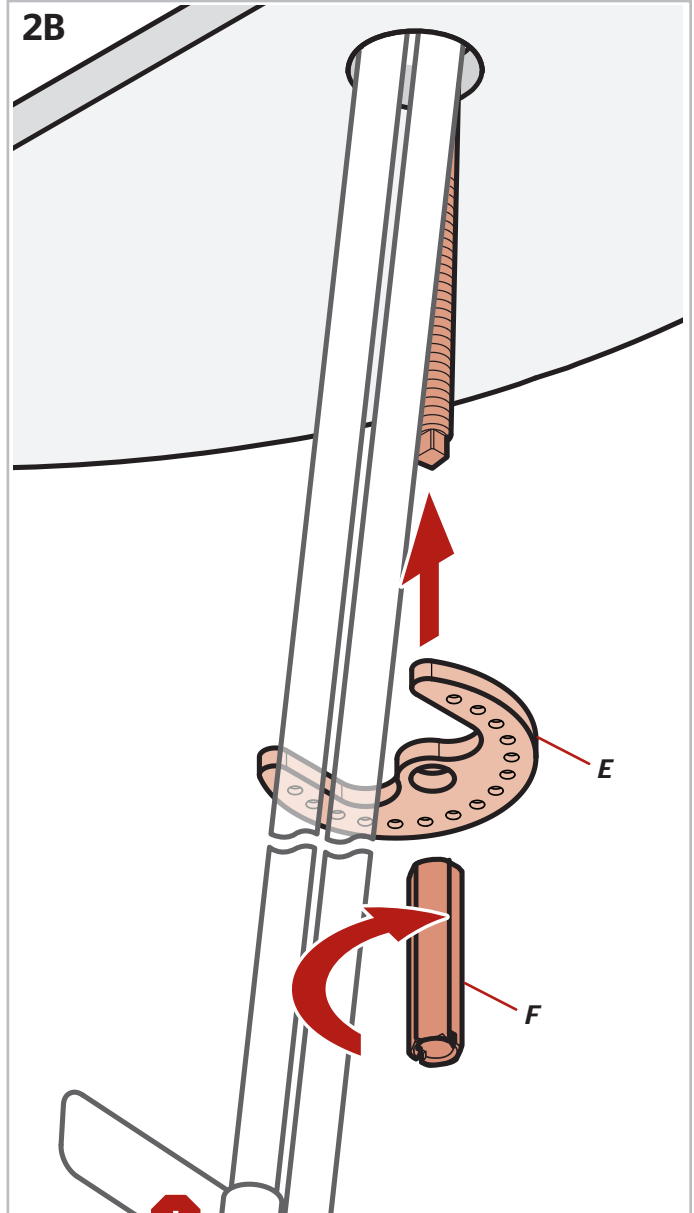
**A****B****E****F****2A****2B**

**Be sure the spout body (A) is centered & facing forward.  
IMPORTANT: DO NOT OVERTIGHTEN.**

Cerciórese que la estructura del surtidor (A) esté centrada y orientada hacia adelante.  
IMPORTANTE: NO APRIETE EXCESIVAMENTE.

Assurez-vous que le corps du bec (A) est centré et tourné vers l'avant.  
IMPORTANT: NE PAS TROP SERRER.

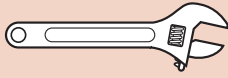
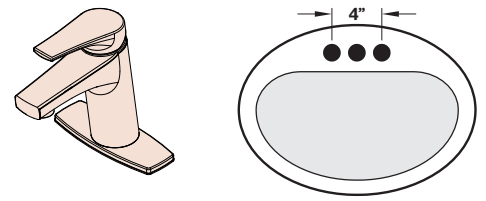
**2****OPTION 2: Install Faucet with Deckplate****OPCIÓN 2: Instale el grifo con la placa de cubierta****OPTION 2: Installer le robinet avec le plate-forme**

Adjustable Wrench  
Llave ajustable  
Clé réglable

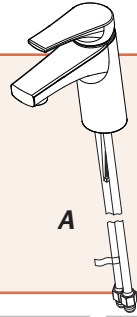

A

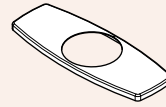

C



D



E

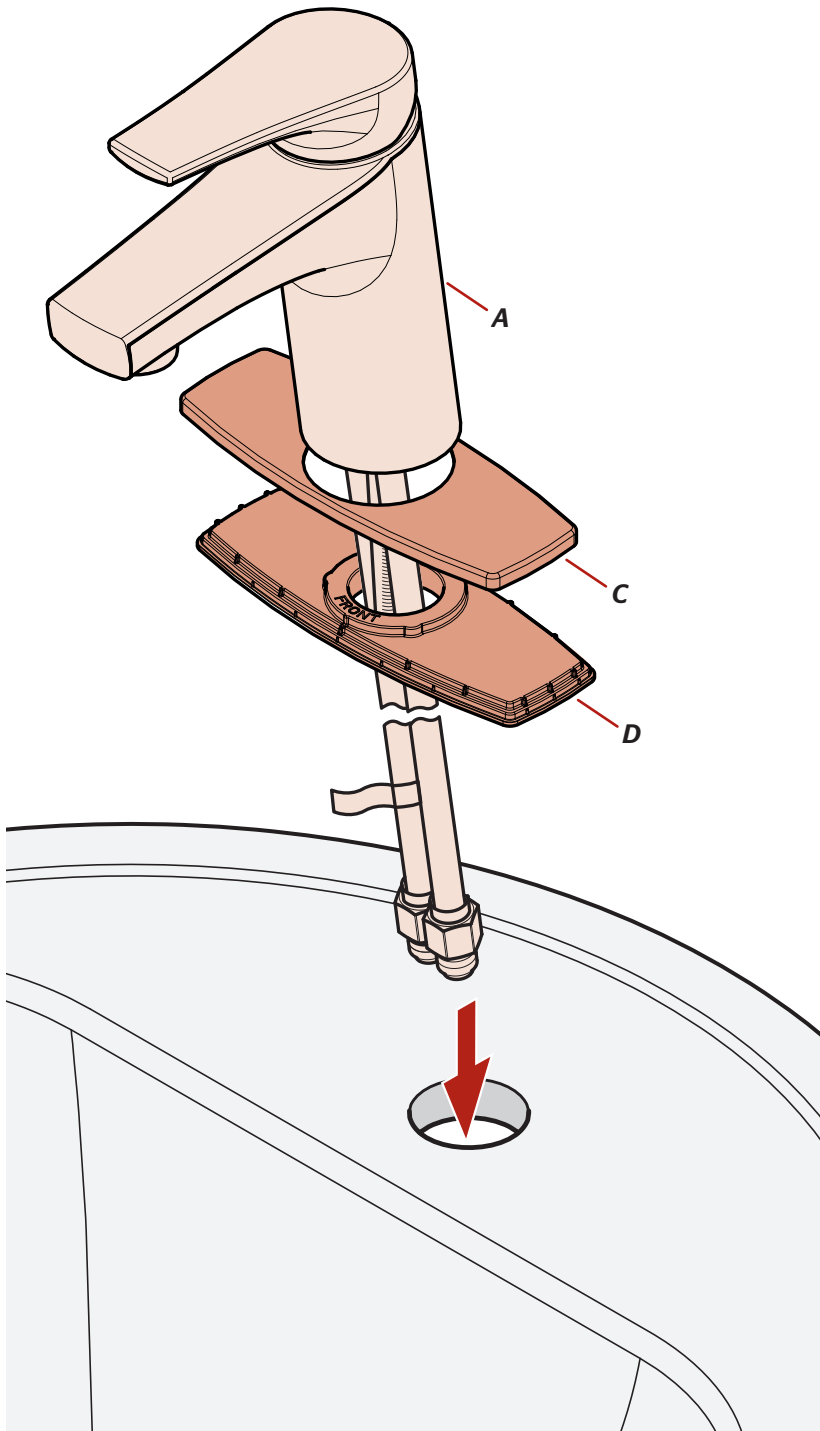
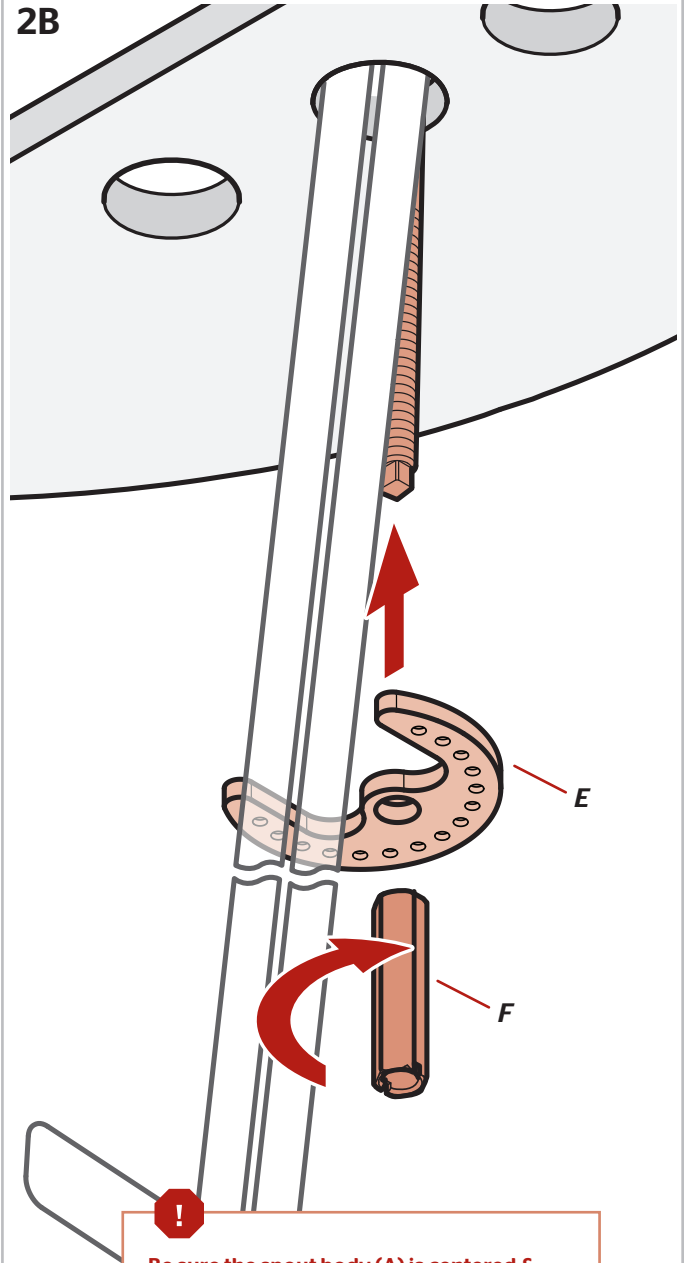

F

**2A****2B**

**Be sure the spout body (A) is centered & facing forward.  
IMPORTANT: DO NOT OVERTIGHTEN.**

Cerciórese que la estructura del surtidor (A) esté centrada y orientada hacia adelante.  
IMPORTANTE: NO APRIETE EXCESIVAMENTE.

Assurez-vous que le corps du bec (A) est centré et tourné vers l'avant.  
IMPORTANT: NE PAS TROP SERRER.

### 3 Connect Water Supply Lines Conecte las tuberías de suministro de agua Raccorder les conduites d'alimentation en eau

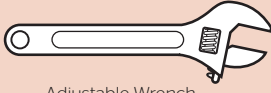

Adjustable Wrench  
Llave ajustable  
Clé à mollette

No Parts Required for This Step  
No se necesitan piezas para este paso  
Pas de pièce nécessaire pour cette étape



**Hot water supply line connects to left inlet as indicated tag.  
Cold water supply line connects to right inlet.**

**NOTE: Incorrect application of supply lines and fittings may result in the failure or leak of the supply lines and fitting.**

La línea de suministro de la agua caliente conecta con la entrada izquierda indicada por la etiqueta.  
La línea de suministro de la agua fría conecta con la entrada derecha.

**NOTA:** El uso incorrecto de líneas de suministro y de guarniciones puede dar lugar a la falta o al escape de las líneas de suministro y de la guarnición.

La canalisation d'alimentation d'eau chaude se relie à l'admission gauche indiquée par l'étiquette.  
La canalisation d'alimentation d'eau froide se relie à l'admission droite.

**REMARQUE :** L'application incorrecte des canalisations et des garnitures d'alimentation peut avoir comme conséquence l'échec ou la fuite des canalisations et de l'ajustage de précision d'alimentation.

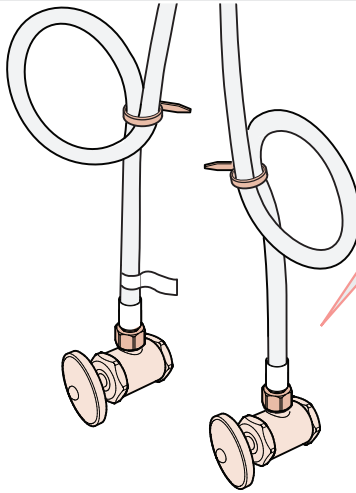
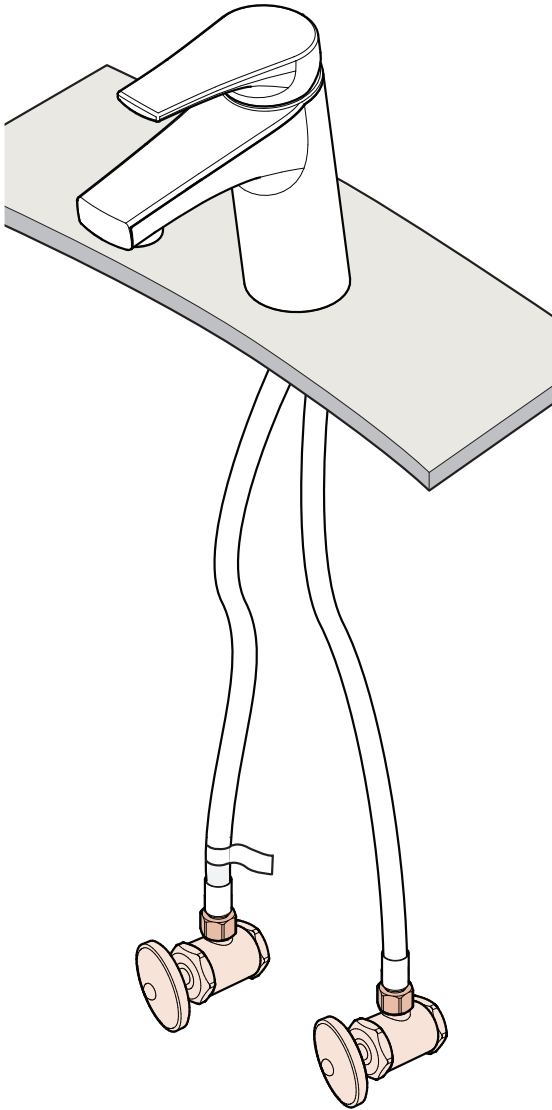

**Loop & secure if necessary.**

El lazo y asegura en caso de necesidad.  
La boucle et fixent au besoin.

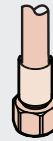

**3/8 inch female connection. Adapter may be required (not supplied).**

Conexión de la hembra de 3/8 pulgada.  
El adaptador puede ser requerido (no proveído).

Reccordement de femelle de 3/8 pouce.  
L'adaptateur peut être exigé (non fourni).

**3A**

**x2**

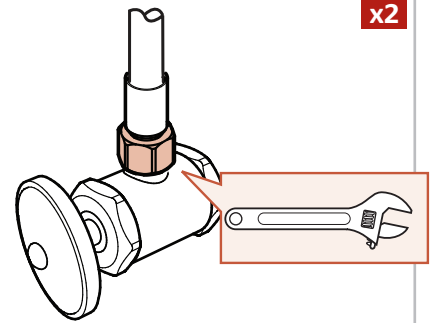

# 4 Prepare & Install Push & Seal™ Drain

## Prepare y instale cuerpo de drenaje Push & Seal™

### Préparez & installez le corps de drainage Push & Seal™

No Tools Required for This Step  
 No se necesitan herramientas para este paso  
 Pas d'outil nécessaire pour cette étape

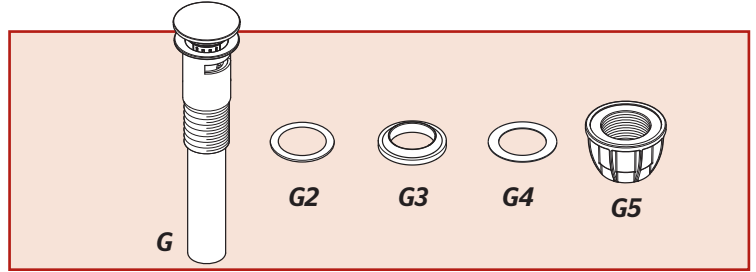

#### 4A Disassemble Pop-Up

##### Desensamble el cuerpo de drenaje

##### Démontez le corps de drainage

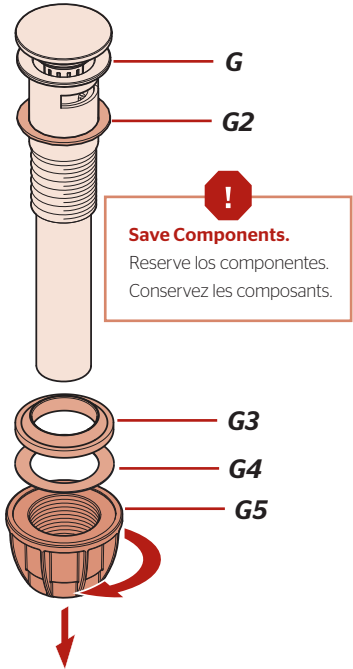

#### 4B

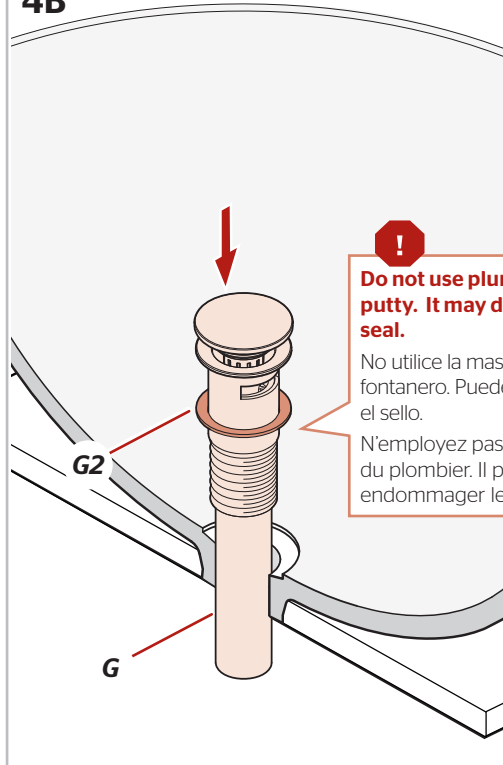

#### 4C

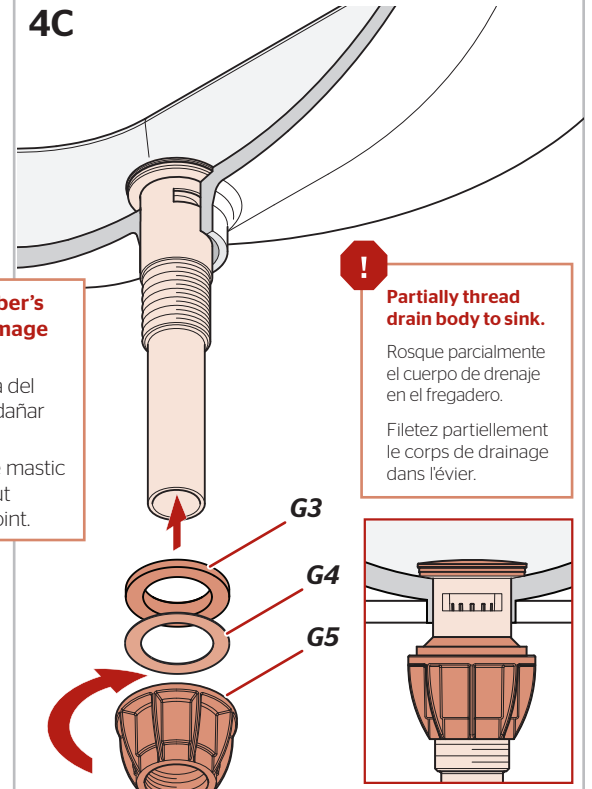

#### 4D

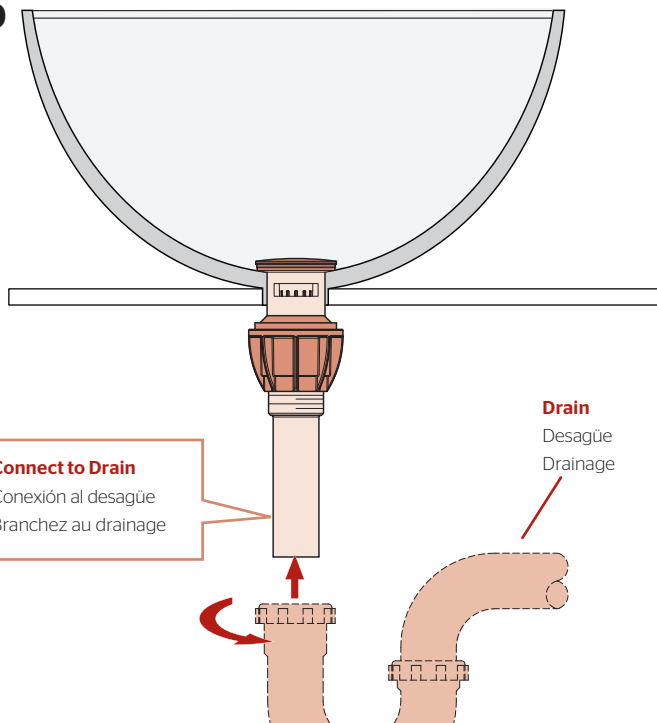

#### 4E

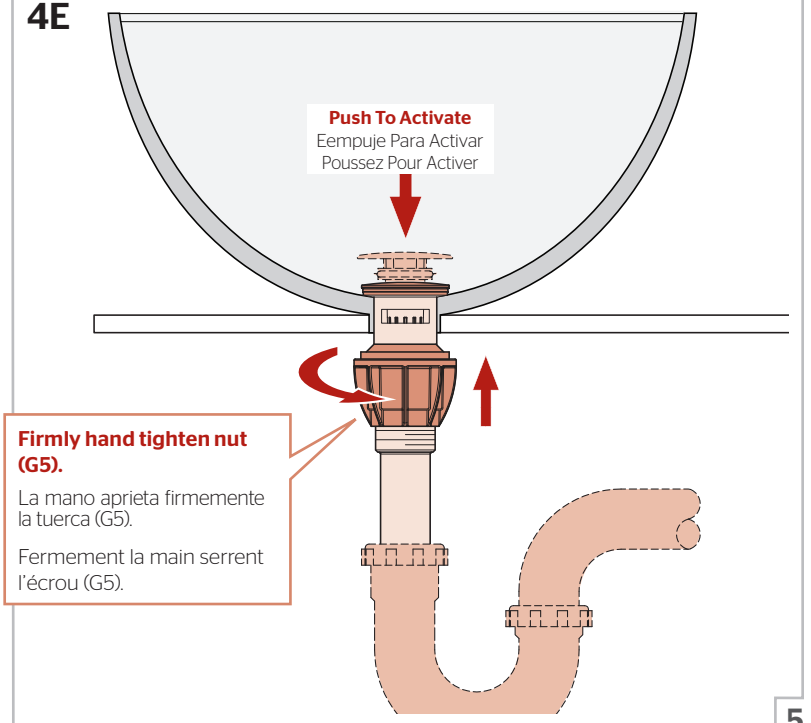

## 5 Turn On Water & Confirm Proper Installation

Active el suministro de agua y confirme que la instalación está adecuadamente efectuada

Ouvrez l'eau et confirmez que l'installation est correcte

### 5A

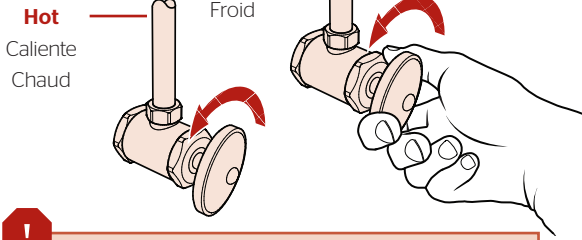

#### Check for leaks above and below the sink.

Revise si hay fugas encima y debajo del fregadero

Assurez-vous qu'il n'y a pas de fuite au dessus ou au dessous du lavabo.

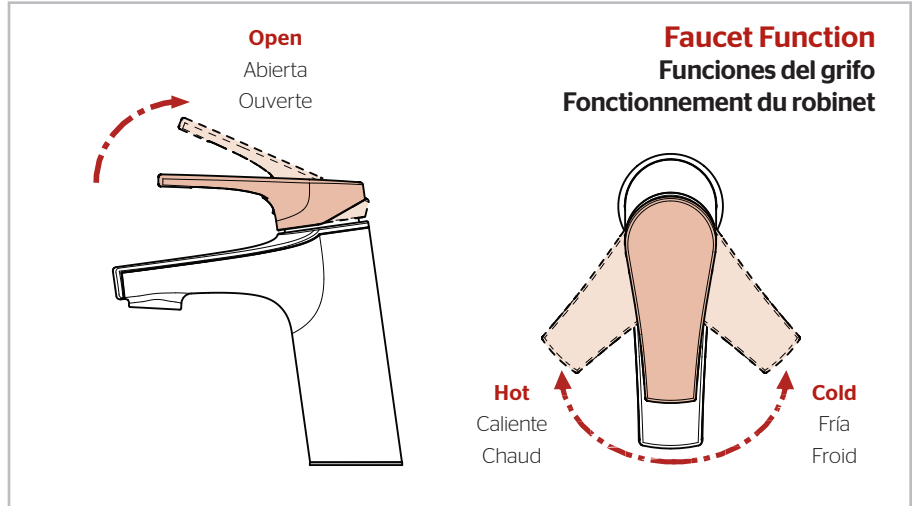

## 6 Flush the Faucet

Enjuague el grifo

Vidangez l'robinet

### 6A Remove Aerator Retire el aereador Retirez l'aérateur

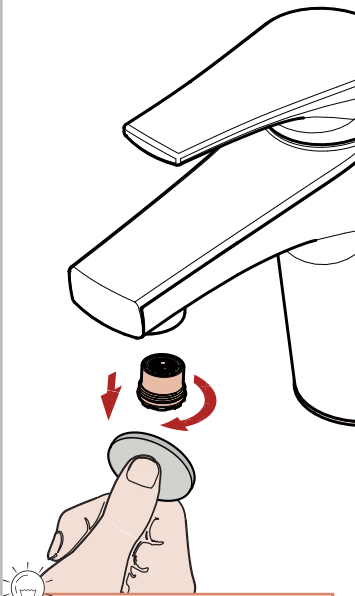

#### Tip • Indicio • Conseil

Use a Coin to turn  
Utilice una moneda para girar  
Utilisez une pièce pour tourner

### 6B

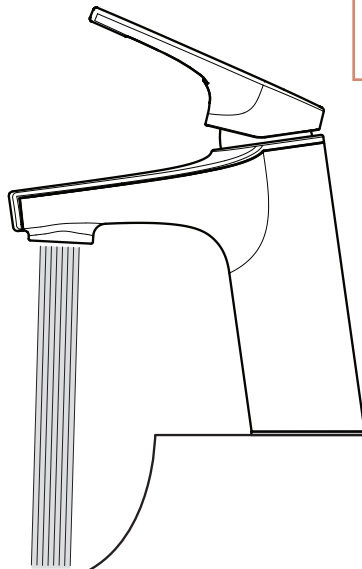

Open Slowly  
Abra lentamente  
Ouvrez lentement

#### Allow hot & cold water to run for at least 15 seconds each.

Deje correr el agua caliente y fría durante al menos 15 segundos cada una.

Laissez couler l'eau chaude et l'eau froide pendant au moins 15 secondes.

### 6C Reinstall Aerator Reinstale el aereador Réinstallez l'aérateur

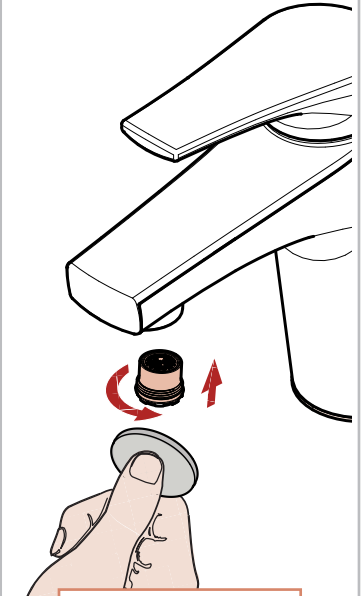

#### Hand Tighten

Apriete con la mano  
Serrez manuellement

For Additional Installation Help:  
Para la instalación adicionales de ayuda:  
Pour les aides supplémentaires à l'installation:

Pfister®

1-800-PFAUCET (732-8238)  
pfisterfaucets.com